

LN52

GaAs Infrared Light Emitting Diode

For optical control systems

■ Features

- High-power output, high-efficiency : $P_O = 6 \text{ mW (typ.)}$
- Wide directivity, matched for external optical systems : $\theta = 100 \text{ deg.}$
- Infrared light emission close to monochromatic light : $\lambda_p = 950 \text{ nm}$
- Optimum for measuring instruments and control equipments in combination with silicon photodetectors

■ Absolute Maximum Ratings ($T_a = 25^\circ\text{C}$)

Parameter	Symbol	Ratings	Unit
Power dissipation	P_D	160	mW
Forward current (DC)	I_F	100	mA
Pulse forward current	I_{FP}^*	2	A
Reverse voltage (DC)	V_R	3	V
Operating ambient temperature	T_{opr}	-25 to +85	$^\circ\text{C}$
Storage temperature	T_{stg}	-30 to +100	$^\circ\text{C}$

* $f = 100 \text{ Hz}$, Duty cycle = 0.1 %

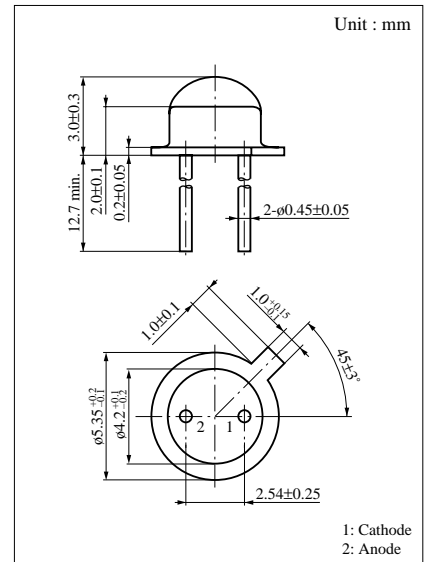

■ Electro-Optical Characteristics ($T_a = 25^\circ\text{C}$)

Parameter	Symbol	Conditions	min	typ	max	Unit
Radiant power	P_O	$I_F = 100\text{mA}$	3.5	6		mW
Peak emission wavelength	λ_p	$I_F = 100\text{mA}$		950		nm
Spectral half band width	$\Delta\lambda$	$I_F = 100\text{mA}$		50		nm
Forward voltage (DC)	V_F	$I_F = 100\text{mA}$		1.25	1.6	V
Reverse current (DC)	I_R	$V_R = 3\text{V}$			10	μA
Capacitance between pins	C_t	$V_R = 0\text{V}$, $f = 1\text{MHz}$		50		pF
Rise time	t_r	$I_{FP} = 100\text{mA}$		1		μs
Fall time	t_f			1		μs
Half-power angle	θ	The angle in which radiant intensity is 50%		100		deg.

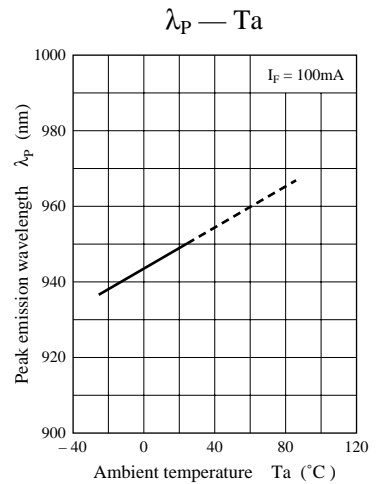
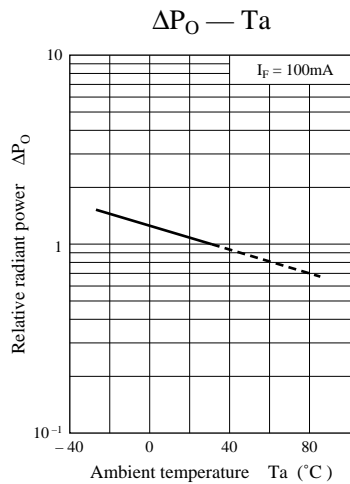
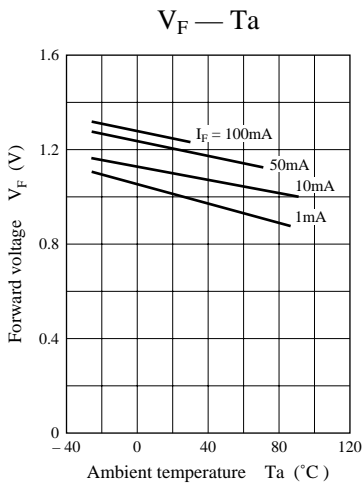
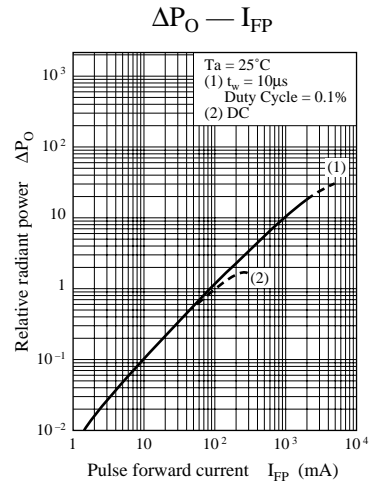
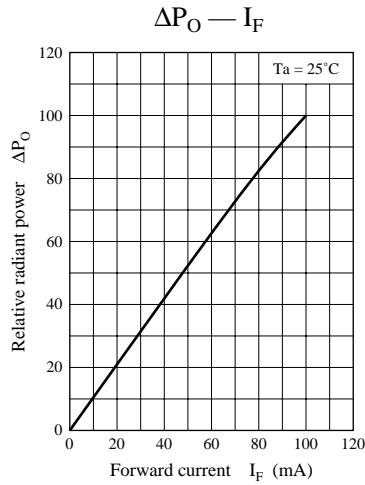
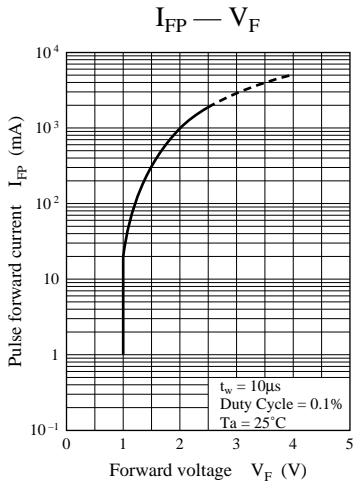
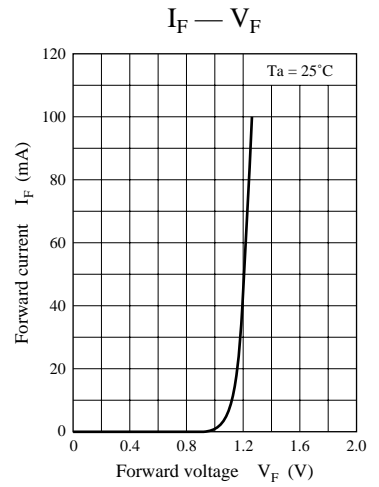
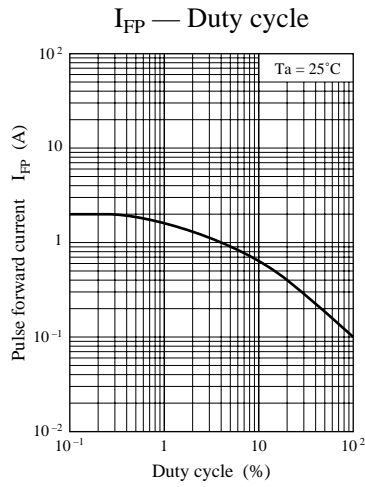
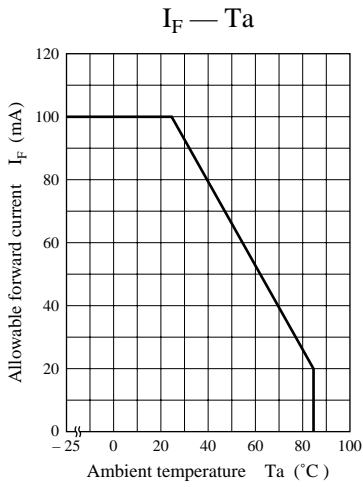

Spectral characteristics

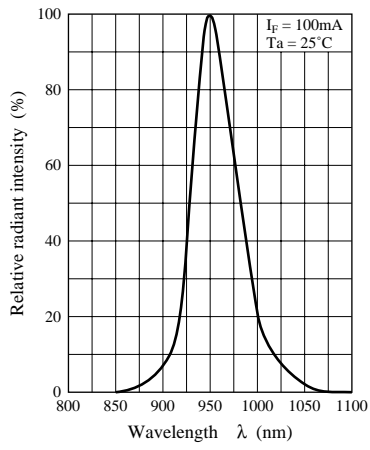

Directivity characteristics

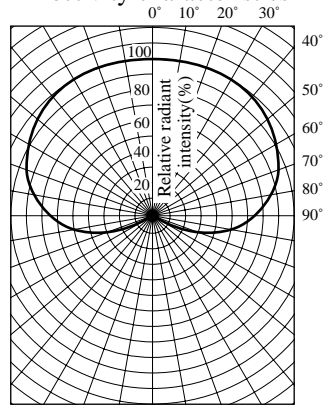

Frequency characteristics

